

M8 female 90° with cable

PUR 8x0.14 3m

Female 90°

M8, 8-pole

with cable sleeves

Plastic housings with good resistance against chemicals and oils.

The resistance to aggressive media should be individually tested for your application. Further details on request.

Further cable lengths on request.

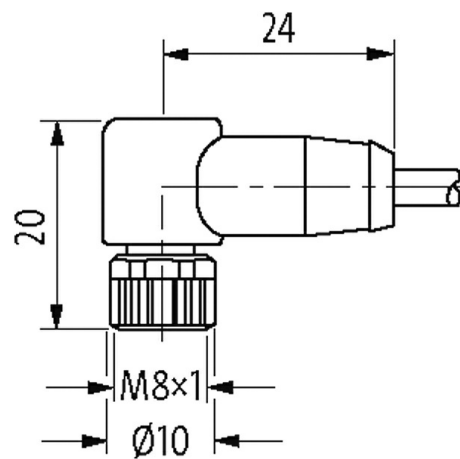
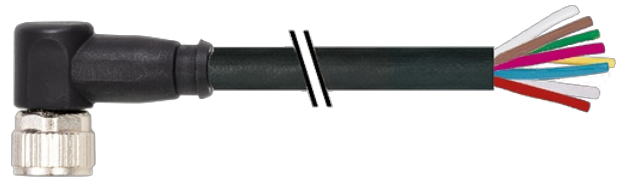
Illustration

Female

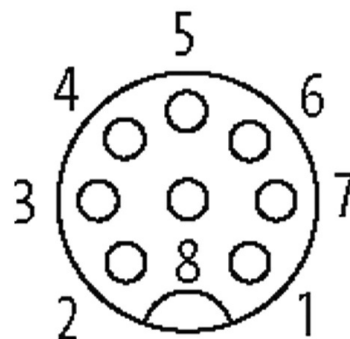

Product may differ from Image

Approvals

**Form**

Form 08971

General data

Mounting method	inserted, tightened
Material (contact)	Copper alloy
Material (contact surface)	Au
Material (gasket)	FPM
Pollution Degree	3/2
Temperature range	-30...+80 °C

Cables

Cable identification	696
Material (wire)	Cu wire, bare
Resistor (core)	max. 78 Ω/km (20 °C)
Single wire Ø (core)	0.1 mm
Construction (core)	18× 0.1 mm (multi-strand wire class 6)
Diameter (core)	8× 0.14 mm ²
AWG	similar to AWG 14
Material (wire isolation)	PP
Wire-Ø incl. isolation	1.07 mm ±5%
Stranding combination	8 wires twisted around central filler
Shield	no
Material (jacket)	PUR
Outer-Ø (jacket)	5.5 mm ±5%
Color (jacket)	black
Nominal voltage	300 V
Test voltage	3000 V AC
Temperature range (fixed)	-30...+80 °C
Temperature range (mobile)	-15...+80 °C
Bend radius (moving)	6× outer Ø
No. of bending cycles (C-track)	max. 2 Mio. (25 °C)
Travel speed (C-track)	max. 5 m/s
Acceleration (C-track)	max. 10 m/s ²
Jacket Color	black

Technical Data

Operating voltage	max. 30 V AC/DC
Operating current per contact	max. 1.5 A
No. of poles	8
LED display	no
Locking of ports	Screw thread (M8×1 mm) recommended torque 0.4 Nm, self-securing
Compression gland	M8 (SW9)
Protection	IP67 inserted and tightened (EN 60529)
Locking material	Zinc die casting, matte nickel plated
Material	TPU
Mating cycles	≥ 100

Commercial data

country of origin	CZ
customs tariff number	85444290
EAN	4048879745246
eClass	27279218
Packaging unit	1

Sketch

1	⌋	white
2	⌋	brown
3	⌋	green
4	⌋	yellow
5	⌋	gray
6	⌋	pink
7	⌋	blue
8	⌋	red

Product may differ from Image